

MODEL 46 AND 81 CALCULATOR  
SERVICE MANUAL

PART NUMBER 00046-90031

PRINT DATE JAN. 1975



# Model 46 and 81 CALCULATOR

## SERVICE MANUAL

-hp- Part No. 00046-90031

Revised January 1975



HEWLETT-PACKARD CALCULATOR PRODUCTS DIVISION

P.O. Box 301, Loveland, Colorado 80537, Tel. (303) 667-5000

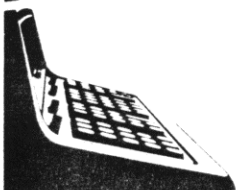

# TABLE OF CONTENTS

## CHAPTERS

---

<b>CHAPTER 1: INTRODUCTION</b>	
PURPOSE OF THE MANUAL .....	1-1
CALCULATOR SERVICE REPAIR KIT .....	1-1
<b>CHAPTER 2: INSTALLATION</b>	
POWER REQUIREMENTS .....	2-1
SETTING THE VOLTAGE SELECTOR CARD .....	2-1
PRINTER PAPER .....	2-2
MODEL 46 OPTION INSTALLATION .....	2-2
MODEL 81 OPTION INSTALLATION .....	2-2
<b>CHAPTER 3: INSTRUMENT MAINTENANCE</b>	
GENERAL INFORMATION .....	3-1
PRINTER MAINTENANCE .....	3-1
<b>CHAPTER 4: ASSEMBLY REPLACEMENT</b>	
CALCULATOR ASSEMBLY ACCESS .....	4-1
Keyboard Removal .....	4-1
Fatherboard or Display Board .....	4-1
Line ON/OFF Switch .....	4-3
Printer .....	4-3
Motherboard Removal .....	4-3
ASSEMBLY INSTALLATION .....	4-3
<b>CHAPTER 5: TROUBLESHOOTING</b>	
INITIAL CHECKS .....	5-1
MODEL 46 DISPLAY CHECKOUT .....	5-1
MODEL 46 PRINTER CHECKOUT .....	5-1
MODEL 81 PRINTER AND DISPLAY CHECKOUT .....	5-2
BLOCK DIAGRAM .....	5-2
<b>CHAPTER 6: REPLACEABLE PARTS</b>	
INTRODUCTION .....	6-1

## TABLES

---

Line Voltage/Fuse Selection .....	2-1
Equipment Required for P.M.'s .....	3-1
Calculator Failure Symptoms .....	5-3
Model 46 Key Sequence Test .....	5-4
Model 81 Key Sequence Test .....	5-5
Replaceable Parts .....	6-2

**FIGURES**

---

The Voltage Selector Card .....	2-1
Installing Printer Paper .....	2-2
Buffered Keyboard Installation .....	2-3
The Cutting Bar and Print-drum Cover .....	3-1
The 6" Strip of Paper Inserted During Cleaning .....	3-2
Calculator Access Screws .....	4-1
Calculator Assemblies .....	4-2
Primary Power Schematic .....	5-6
A4 Fatherboard Schematic .....	5-7
Keycap Part Numbers .....	6-1



# Chapter 1

## INTRODUCTION

### PURPOSE OF THE MANUAL

This manual is intended for use by HP Customer Engineers and provides information to enable a board level repair of a Model 46 or Model 81 calculator. All information is presented assuming that you are familiar with calculator operation.

### CALCULATOR SERVICE REPAIR KITS

The Model 46 Service Kit (11490A) and Model 81 Service Kit (11491A) contain a complete, operational calculator. Additional or replacement kits may be ordered from Calculator Products Division (CPD), Loveland, and GmbH. Replacement parts should be ordered from either CSC or PCE whichever is appropriate.

#### 11490A Service Kit(46A)

Description	HP Part No.
Mother Board	00046-66500
Printer	0950-0538
Display	00046-66541
Keyboard	00046-67930
Rear Panel	00046-60301
Cabinet Top	00046-64401
Printer Cover	4040-0926
Cabinet Gasket	5040-0983
Cabinet Bottom	4040-0971
Bottom Cover	00046-04101
Support Pad	5040-7420
Paper Bucket	4040-0983
Reference Guide Box	5040-7553
Service Manual	00046-90031
Operating Guide	00046-90005
Service Cards	00046-90010
Printer Ribbon	9282-0511
Printer Paper	9281-0415
Paper Shaft	09805-23751
.25 Amp Fuse	2110-0201
.5 Amp Fuse	2110-0202
AC Power Cord	8120-1378
Paper Load Decal	7120-3569
Ribbon Load Decal	7120-3570
Error Note Decal	7120-3584
Caution Label	7120-3528

#### 11491A Service Kit(81A)

Description	HP Part No.
Mother Board	00081-66500
Buffer Assembly	00081-66542
Buffer-Display Assembly	00081-66543
Printer	0950-0564
Keyboard	00081-67930
Service Manual	00046-90031
Operating Manual	00081-90000
Service Cards	00081-90010
.25 Amp Fuse	2110-0201
.5 Amp Fuse	2110-0202
Printer Paper	9281-0415
Printer Ribbon	9282-0511





# Chapter 2

## INSTALLATION

### POWER REQUIREMENTS

#### CAUTION

INSTRUMENT DAMAGE MAY RESULT IF AC POWER IS APPLIED TO THE INSTRUMENT WITHOUT PROPER INSTALLATION OF THE VOLTAGE SELECTOR CARD AND THE CORRECT FUSE.

The calculator will operate on a line voltage of either 100, 120, 220 or 240V ac (+8%, -16%). The line frequency must be within the range of 48 to 66 Hz (inclusive).

#### NOTE

Model 46 calculators with serial numbers less than xxxxA03350 may only be used on the 120V or 240V ac selector card positions.

### SETTING THE VOLTAGE SELECTOR CARD

The voltage selector card can be installed by performing the following procedure (refer to figure 2-1):

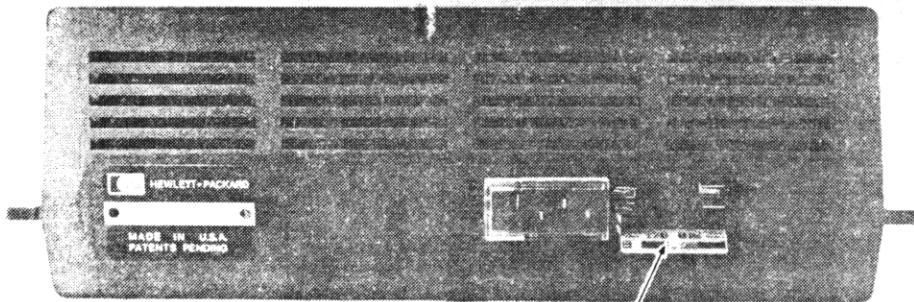

Voltage Selector Card (Shown in 120V Position)

**Figure 2-1. The Voltage Selector Card**

1. Slide the clear plastic window on the power module all the way to the left.
2. Pull the FUSE PULL lever out to release the fuse; remove the fuse.
3. If the selector card is installed, it may be removed by using a sharp-pointed object (e.g., a ball-point pen) to pry the card out of the module.
4. Install the card into the power module. The proper voltage selection is made when the number for the selected voltage is visible after the card is installed.
5. Return the FUSE PULL lever to its original position.
6. Install the appropriate fuse (see Table 2-1) into the fuse clip and slide the plastic window to the right.

**Table 2-1. Line Voltage/Fuse Selection.**

LINE VOLTAGE	SETTING	FUSE	-hp- PART NUMBER
84V 108V	100V	.5 amp SB	2110-0202
101V 130V	120V	.5 amp SB	2110-0202
185V 237V	220V	.25 amp SB	2110-0201
202V 259V	240V	.25 amp SB	2110-0201

The following procedure should be used when replacing printer paper (see Figure 2-2):

1. Insert the metal shaft through the center of the roll of paper. Any standard 2¼ inch adding machine paper may be used.
2. Place the metal shaft in the guides so that the paper will unwind from the bottom of the roll.
3. Pull about four inches of paper from the roll and fold the leading edge back about one inch.
4. Push the paper straight down into the slot just forward of the  arrow, while at the same time pressing the **PAPER** key. Ensure that the paper passes behind the cutting bar.
5. Press **PAPER** a few times to verify that the paper is advancing properly.

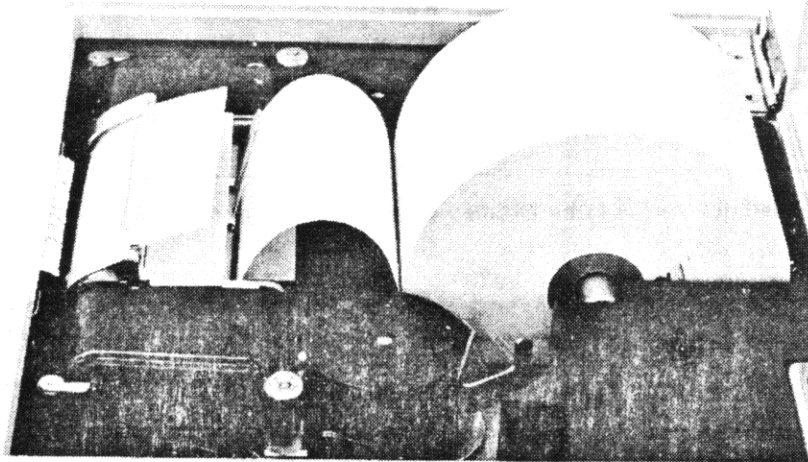

Figure 2-2. Installing Printer Paper.

**MODEL 46,  
OPTION  
INSTALLATION**

The only option available for the calculator is a display (Option 001). The display can be installed by replacing the A4 father board assembly (00046-69540) with a display assembly A5 (00046-69541). (See Figure 4-2.)

**MODEL 81  
OPTION  
INSTALLATION**

The standard Model 81 has a printer and no display. The following options are available for the Model 81. All these options may be field installed.

OPTION	DESCRIPTION	BOARD	ACCESSORY NO.
001	Display	66541	11369A
002	Buffered keyboard	66542	11370A
003	Buffered keyboard and display	66543	11371A

**Option Installation**

OPTION 001 is installed by replacing the A4 father board assembly (00046-66540) with a display assembly A5 (00046-66541).





# Chapter 3

## INSTRUMENT MAINTENANCE

The calculator can be cleaned by using a soft, moist cloth. The use of abrasive or harsh detergents should be avoided, and moisture should not be allowed to penetrate inside the calculator. Avoid scratching the display window.

### GENERAL INFORMATION

To avoid printer failures, the manufacturer recommends that the following procedure be performed after 10 rolls of paper or every 3 months, whichever occurs first.

### PRINTER MAINTENANCE

**Table 3-1. Equipment Required For P.M.'s.**

DESCRIPTION	-hp- PART NUMBER
*stiff bristle brush	—
soft bristle brush	8520-0015
soft cloth	—

1. Tear off and save a 6" strip of printer paper.
2. Lift the printer access cover and remove the paper cutting bar and print-drum cover (see Figure 3-1) by pulling each device up until it releases.

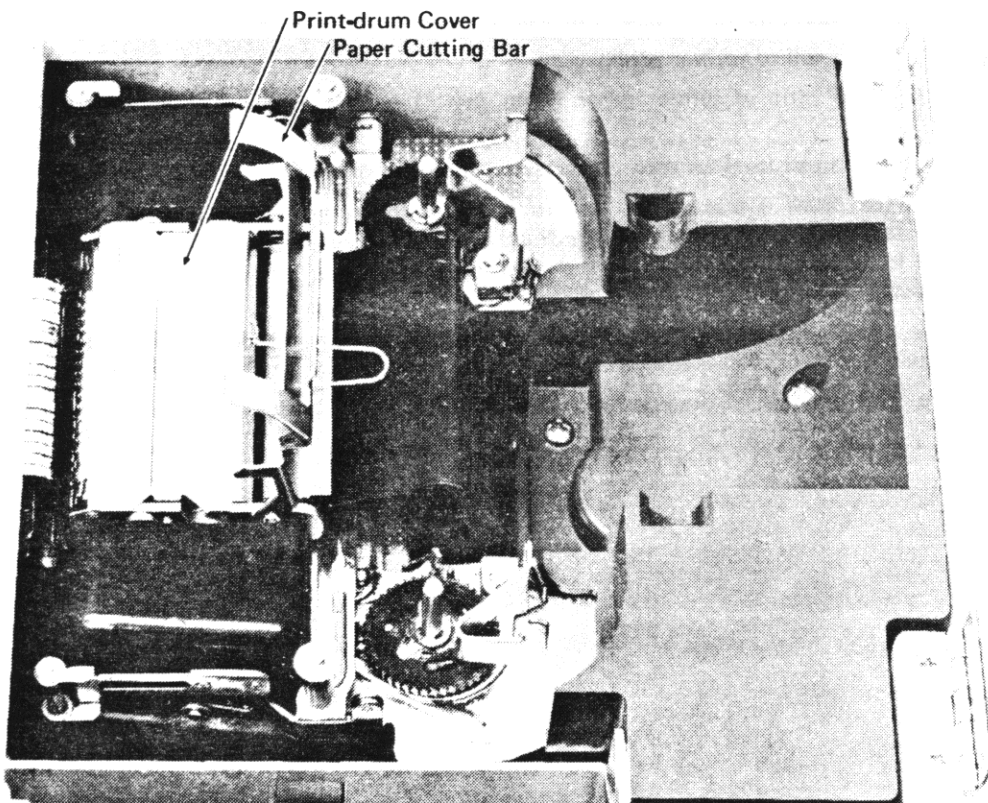

**Figure 3-1. The Cutting Bar and Print-drum Cover.**

One of the brushes in the service kit can be trimmed to a ¼" length for this purpose, or a standard typewriter brush can be used.

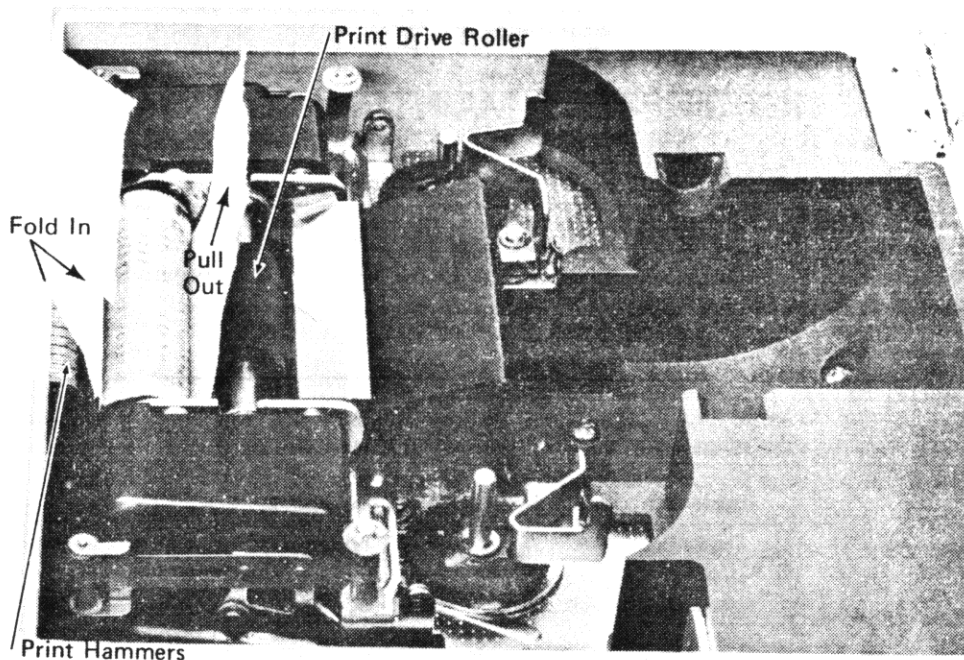

**Figure 3-2. The 6" strip of paper inserted during cleaning.**

3. Remove the ribbon and inspect it for wear. If the ribbon has begun to fragment or fray, the ribbon should be replaced to prevent ribbon particles from jamming the printer mechanism.
4. Remove the roll of printer paper.
5. Slide the 6" strip of printer paper (from step 1) around the print drum (see Figure 3-2).
6. Use a stiff brush to clean each character on the print drum.
7. When the drum is clean, fold the front end of the printer paper inward about 1" from the end and firmly crease the fold. Then, pull the paper out by the back end until it is clear of the drum. Care should be taken not to spill the loose particles as the paper is removed.
8. Use a flexible brush to clean as much of the paper chips and ribbon particles from the printer as possible — especially in the area of the print drum.
9. Wipe the remainder of the printer surface areas clean with a soft cloth.

# Chapter 4

## ASSEMBLY REPLACEMENT

This section provides the information for accessing each of the calculator assemblies.

### CALCULATOR ASSEMBLY ACCESS

#### CAUTION

ALL AC POWER TO THE CALCULATOR MUST BE DISCONNECTED BEFORE ANY ASSEMBLY IS INSTALLED OR REMOVED.

The printer paper and top cover must be removed to enable keyboard access. Figure 4-1 shows the five screws which secure the top cover to the chassis. Disconnect the connector on the line ON/OFF switch cable to enable keyboard removal.

### KEYBOARD REMOVAL

#### CAUTION

THE KEYBOARD INTERCONNECTING CABLES CAN BE EASILY DAMAGED DURING KEYBOARD INSTALLATION OR REMOVAL.

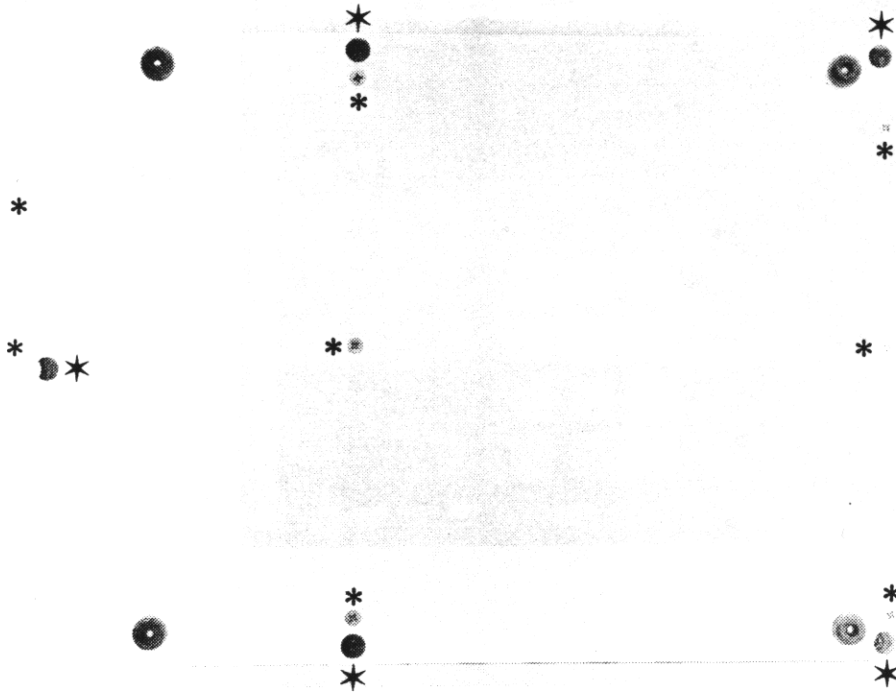

Remove \* for Top Cover Removal

Remove \* for Bottom Cover Removal

Figure 4-1. Calculator Access Screws.

Once the top cover and keyboard have been removed, the father board (A4 or A5) can be removed.

### FATHERBOARD OR DISPLAY BOARD

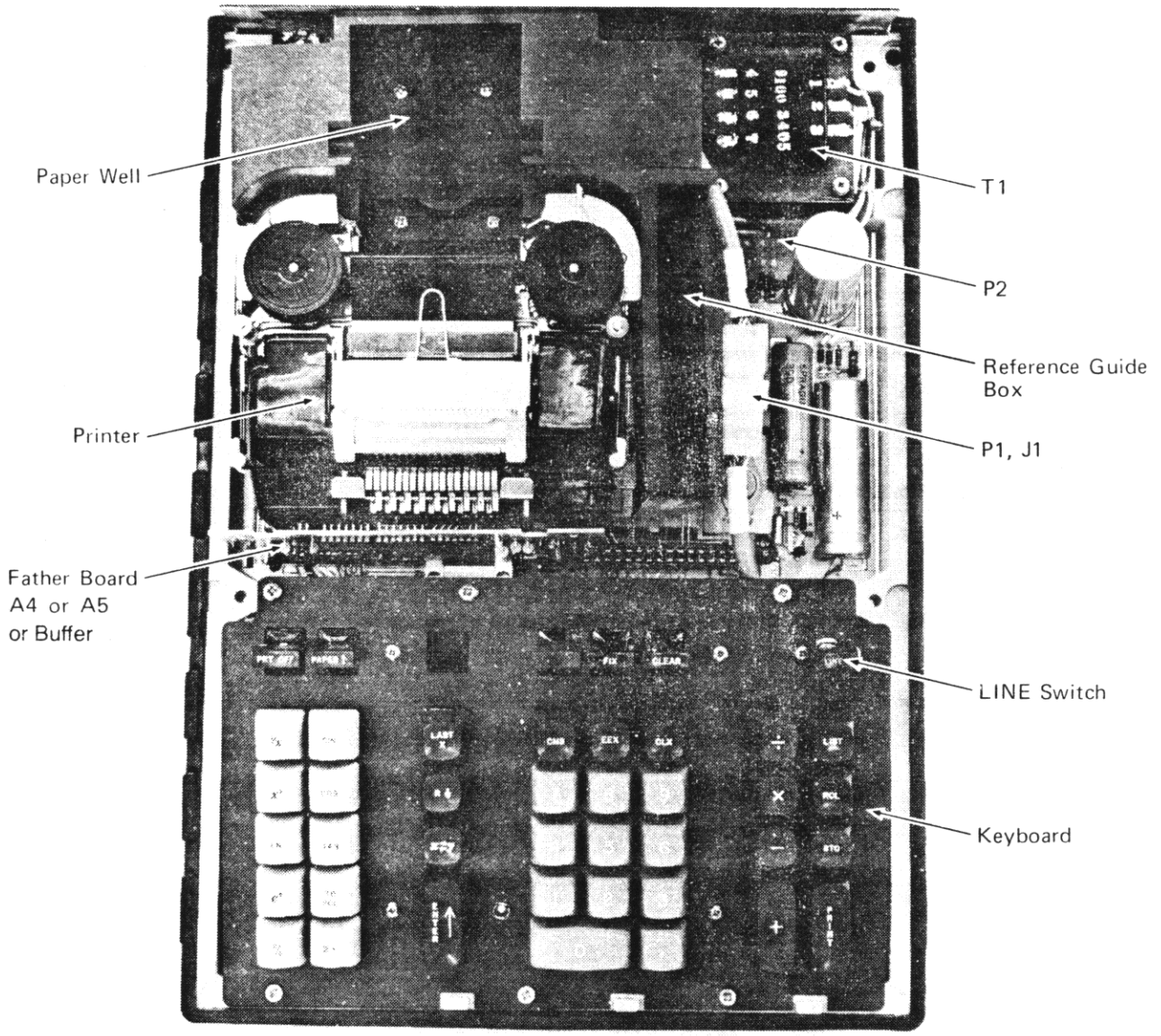

Figure 4-2. Calculator Assemblies



---

## LINE ON/OFF SWITCH

The main power switch can be removed by disconnecting the connector in the line ON/OFF switch cable, and removing the switch from the keyboard.

---

## PRINTER

The printer paper, top cover, bottom cover, and paper well must all be removed before the printer can be removed. Disconnect the printer signal cable and remove the four screws which secure the printer to the mother board.

**CAUTION**

THE PRINTER MUST BE HANDLED AND PACKAGED CAREFULLY TO AVOID ANY DAMAGE TO PRINTER PARTS.

---

## MOTHER BOARD REMOVAL

The following assemblies must be removed from the calculator before the mother board can be removed:

1. Paper
2. Top and bottom covers
3. Father board (A4 or A5)
4. Keyboard
5. Paper well and support bracket
6. Printer
7. Transformer Plug
8. Reference guide box

Once all of these assemblies have been removed, the mother board can be disconnected by removing the screws which secure the mother board to the chassis and lifting the board from the mainframe.

The mother board fits into a slot which is built into the front of the chassis. When the mother board is being installed, be sure that it is properly positioned over the center guide and under the two side guides. Return the previously removed parts.

---

## ASSEMBLY INSTALLATION

Replace each of the assemblies by reversing the procedure given for its removal.



# Chapter 5

## TROUBLESHOOTING

### INITIAL CHECKS

Before an attempt is made to repair the calculator, make the following quick checks to ensure that a failure has actually occurred:

1. Verify the customers complaint and ensure that the complaint is not caused by a user error.
2. If the calculator is completely inoperative, check the line fuse, replace it if necessary. If the line fuse blows again, refer to Table 5-1 for repairing the instrument.

### MODEL 46 DISPLAY CHECKOUT

#### NOTE

Model 46 units with serial numbers less than 200 may not display 0.00 when switched on. This symptom may be corrected by pressing **CLEAR**. The repair of this problem is not included under warranty.

The following key sequence will check the Model 46 display for missing segments.

PRESS:



DISPLAY:



### MODEL 46 PRINTER CHECKOUT

The following key sequence will check the Model 46 printer operation.

PRESS:



CORRECT PRINTOUT:

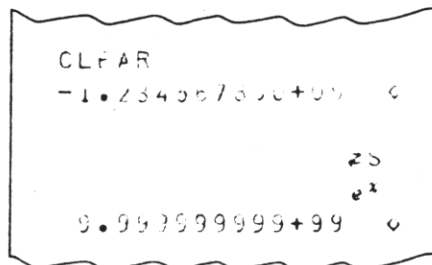

The keyboard and basic Model 46 operation may be checked by performing the Key Sequence Test (Table 5-2).

**MODEL 81  
PRINTER  
AND  
DISPLAY  
CHECKOUT**

The following sequence will check the Model 81 display for missing segments and the printer operation. The AUTO key must be OFF.

KEY	PRINTER	DISPLAY
CLR	CLEAR	0.00
SHIFT		0.00
9		0.00000000 00
-	.00000000+00 -	0.00000000 00
1		1. -09
2		1.2 -08
3		1.23 -07
.		1.23 02
4		1.234 02
5		1.2345 02
6		1.23456 02
7		1.234567 02
8		1.2345678 02
9		1.23456789 02
SAVE	1.234567890+02 †	1.234567890 02
γ <sup>x</sup>	N O T E 1 M †	999999999 99 <span style="float:right">Flashing</span>
CHS	S ‡	-9.999999999 99
◇	-9.999999999+990 <span style="float:right">Red</span>	-9.999999999 99

\*NOTE - SIGN ON EXPONENT

**BLOCK  
DIAGRAM**

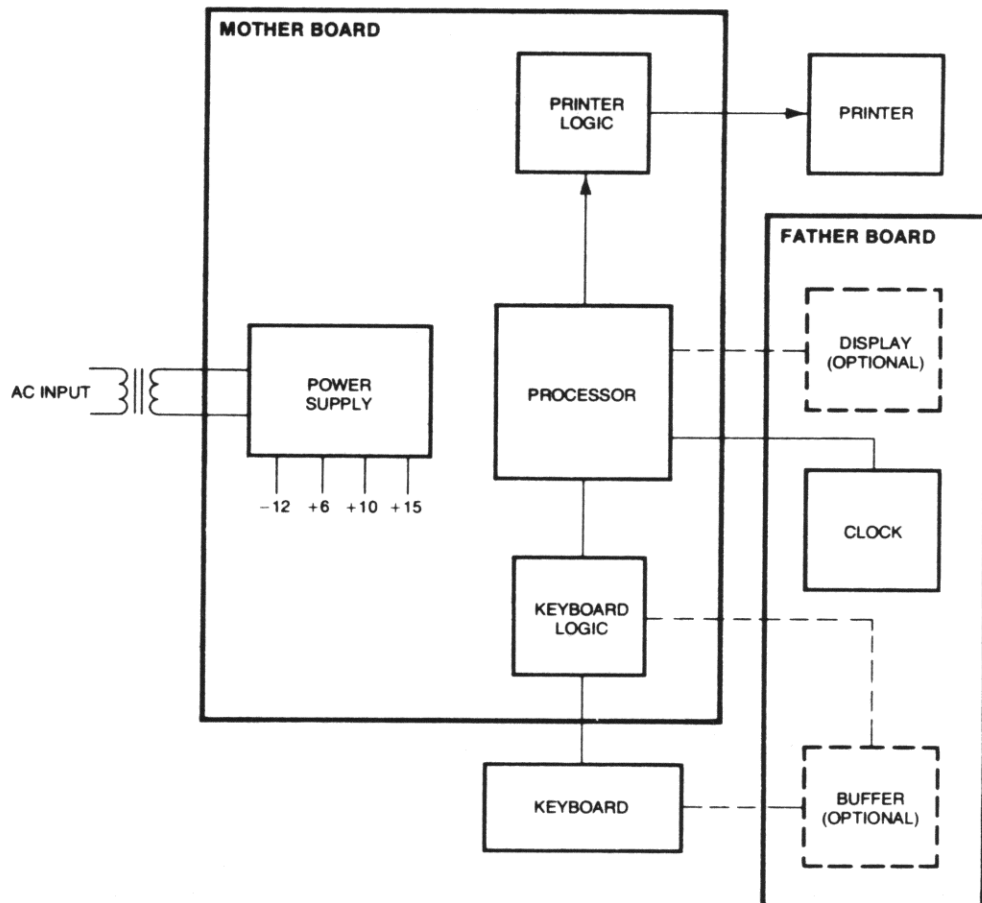

**Table 5-1. Calculator Failure Symptoms**

<b>SYMPTOM</b>	<b>CHECK</b>	<b>RESULT</b>	<b>CAUSE/FIX</b>
Blown Fuse	1. Disconnect P2 insert new fuse	Fuse Blows	Line Switch or Back Panel Assembly Bad, Replace
	2. Reconnect P2 Remove All Assemblies Except Mother Board	Fuse Blows	Mother Board Bad, Replace
	3. Install Assemblies One By One	Defective Assembly Blows Fuse	Replace Defective Assembly
Printer OK: Optional Display Defective	1. Exchange Display (A5)	Problem Fixed	Defective A5 Board
	2. Exchange Mother Board	Problem Fixed	Mother Board Bad, Replace
Optional Display OK: Printer Inoperative	1. Exchange Printer	Problem Fixed	Defective Printer
	2. Exchange Mother Board	Problem Fixed	Mother Board Bad, Replace
Printer and Optional Display Inoperative	1. Exchange A5 Board	Problem Fixed	Replace A5 Board
	2. Exchange Mother Board	Problem Fixed	Mother Board Bad, Replace
Error Note, or Keyboard Control Lost, When key is Pressed	1. Exchange Keyboard	Problem Fixed	Defective Keyboard
	2. Exchange A4 or A5 Board	Problem Fixed	Defective A4 or A5 Board
	3. Exchange Mother Board	Problem Fixed	Defective Mother Board
Inoperative Or Partially Inoperative Data Storage	1. Exchange A4 or A5 Board	Problem Fixed	Defective Board
	2. Exchange Keyboard	Problem Fixed	Defective Keyboard
	3. Exchange Mother Board	Problem Fixed	Defective Mother Board
No Keyboard Control: "Busy" Light On: Printer On But No Printout	1. Exchange Keyboard	Problem Fixed	Defective Keyboard
	2. Exchange A4 or A5 Board	Problem Fixed	Defective Board
	3. Exchange Mother Board	Problem Fixed	Defective Mother Board
One or More Keys Inoperative	1. Exchange Keyboard	Problem Fixed	Defective Keyboard
	2. Exchange Mother Board	Problem Fixed	Defective Mother Board

Table 5-2. Model 46 Key Sequence Test

SEQ NO.	KEY	PRINTER	DISPLAY
1	CLEAR	CLEAR	0.00
2	FIX		
3	8		0.00000000
4	1		1.
5	0		10.
6	ENTER	10.00000000 ↑	10.00000000
7	CLX		0.00000000
8	LAST X	10.00000000 ← 0	10.00000000
9	E EX		1. 00
10	2		1. 02
11	PRINT	1.00000000C+L2 ◊	1.00000000 02
12	CHS	↔S	-1.00000000 02
13	PRINT	1.0000000000+L2 ◊	-1.00000000 02
14	3		3.
15	STO		
16	1	3.00000000 → 1	3.00000000
17	5		5.
18	STO		
19	2	5.00000000 → 2	5.00000000
20	8		8.
21	STO		
22	4	8.00000000 → 4	8.00000000
23	9		9.
24	STO		
25	8	9.00000000 → 8	9.00000000
26	LIST	LIST 3.00000000 ← 1 5.00000000 ← 2 0.00000000 ← 3 6.00000000 ← 4 0.00000000 ← 5 0.00000000 ← 6 0.00000000 ← 7 9.00000000 ← 8 0.00000000 ← 9	
27	RCL		
28	8	9.00000000 ← 8	9.00000000
29	RCL		
30	4	8.00000000 ← 4	8.00000000
31	X	x	72.00000000
32	RCL		
33	1	3.00000000 ← 1	3.00000000
34	÷	÷	24.00000000
35	RCL		
36	2	5.00000000 ← 2	5.00000000
37	-	-	19.00000000
38	xzy	↔	9.00000000
39	+	+	28.00000000
40	PRINT	28.00000000 ◊	28.00000000
41	R↓	↓	8.00000000
42	FIX		
43	2		8.00
44	SIN	S	0.14
45	SHIFT		
46	ASN	AS	8.00
47	COS	C	.99

SEQ NO.	KEY	PRINTER	DISPLAY
48	SHIFT		
49	ACS	AC	8.00
50	TAN	T	0.14
51	SHIFT		
52	ATN	AT	8.00
53	TO POL	TO POLAR 45.00 ◊ 11.31 ◊	11.31
54	SHIFT		
55	REC	TO RECT 8.00 ◊ 8.00 ◊	8.00
56	7		7.
57	Σ+	7.00 Σ+	1.00
58	6		6.
59	Σ+	6.00 Σ+	2.00
60	SHIFT		
61	$\bar{x}$ .Δ	# 2.00 ◊ 0.71 ◊◊ 6.50 $\bar{x}$ ◊	6.50
62	SHIFT		
63	CLR	CLEAR	0.00
64	1		1.
65	2		12.
66	½x	12.00 ½	0.08
67	xzy	↔	0.00
68	SHIFT		
69	y <sup>x</sup>	y <sup>x</sup>	1.00
70	SHIFT		
71	10 <sup>x</sup>	10 <sup>x</sup>	10.00
72	x <sup>2</sup>	x <sup>2</sup>	100.00
73	SHIFT		
74	√x	√	10.00
75	SHIFT		
76	LOG	lg	1.00
77	ln	ln	0.00
78	e <sup>x</sup>	e <sup>x</sup>	1.00
79	%	%	0.00
80	SHIFT		
81	Δ%	NOTE 1 Δ%	0 0 0 0 0
82	SHIFT		
83	n!	n!	1.00
84	SHIFT		
85	RAD	RAD	1.00
86	SHIFT		
87	GRD	GRL	1.00
88	SHIFT		
89	C/I	2.54	2.54
90	SHIFT		
91	π	3.14	3.14
92	SHIFT		
93	DEG	D	3.14
94	SHIFT		
95	DM→	DMS→	3.24
96	SHIFT		
97	DM←	DMS←	3.1416
98	SHIFT		
99	STK	0.00 ←S◊ 1.00 ←S◊ 2.54 ←S◊ 3.14 ←S◊	3.14

Table 5-3. Model 81 Key Sequence Test

KEY	PRINTER	DISPLAY
CLEAR	CLEAR	0.00
1		1.
.		1.
0		1.0
1		1.01
1		1.011
9		1.0119
8		1.01198
0		1.011980
SAVE	1.011980 ↑	1.01
3		3.
6		36.
5		365.
SHIFT		365.
DAT	365.00 DATE 3 12.311980	12.31

KEY	PRINTER	DISPLAY
CLEAR	CLEAR	0.00
1		1.
STO		1.
TL	1.00 →3*	1.00
1		1.
TL	1.00 T	1.00
5		5.
STO		5.
TL	5.00 →3*	5.00
3		3.
TL	3.00 T	2.00
SHIFT		2.00
CAL (TL)	T L FACTF 1.00 S .50 y .50	0.50

KEY	PRINTER	DISPLAY
CLEAR	CLEAR	0.00
9		9.
n	9.00 → N	9.00
9		9.
PMT	9.00 →PT	9.00
1		1.
0		10.
0		100.
FV	100.00 → F	100.00
i	I N T 5.19	5.19

KEY	PRINTER	DISPLAY
CLEAR	CLEAR	0.00
9		9.
n	9.00 → N	9.00
6		6.
i	6.00 → I	6.00
1		1.
0		10.
0		100.
PV	100.00 →P	100.00
SHIFT		100.00
INT	I N T .15	0.15

KEY	PRINTER	DISPLAY
CLEAR	CLEAR	0.00
6		6.
SAVE	6.00 ↑	6.00
X	36.00 ×	36.00
9		9.
÷	9.00 ÷ 4.00 ◊	4.00
STO		4.00
3		4.00
5		5.
Σ+	5.00 Σ+	5.00
RCL		5.00
3	4.00 →3 ↑	4.00
Σ+	4.00 Σ+	9.00
$\bar{x}$	σ N 2.00 4.50	4.50
x:y	.71 ≠	0.71
y <sup>x</sup>	2.90 ◊ M↑	2.90
SHIFT		2.90
$\sqrt{x}$	1.70 ◊ √	1.70
CHS	1.70 ◊ S ◊ -	1.70
*	1.70 ◊ *	0.00

KEY	PRINTER	DISPLAY
CLEAR	CLEAR	0.00
1		1.
SAVE	1.00 ↑	1.00
5		5.
i	5.00 → I	5.00
5		5.
PMT	5.00 →PT	5.00
SHIFT		5.00
BND	P F I C E TO MAT 100.00	100.00

Red

Table 5-3. Model 81 Key Sequence Test (Contd)

KEY	PRINTER	DISPLAY
CLEAR	CLEAR	0.00
1		1.
STO		1.
1	1.00 → 1	1.00
2		2.
STO		2.
2	2.00 → 2	2.00
4		4.
i	4.00 → I	4.00
3		3.
PMT	3.00 → PT	3.00
5		5.
0		50.
PV		50.00
Σ+	50.00 → P I Σ+	3.96
	P V I N T 3.96	

NOTE

1. UNITS WHICH HAVE A WHITE/BLACK WIRE CONNECTED TO PIN A ON THE POWER MODULE MAY BE OPERATED ON EITHER 110, 120, 220, OR 240 VAC LINES. THE CORRECT SELECTOR CARD AND FUSE MUST BE PROPERLY INSTALLED. UNITS WHICH DO NOT UTILIZE THE WHITE/BLACK WIRE CAN ONLY BE OPERATED ON EITHER 120 VAC OR 240 VAC POWER LINES.

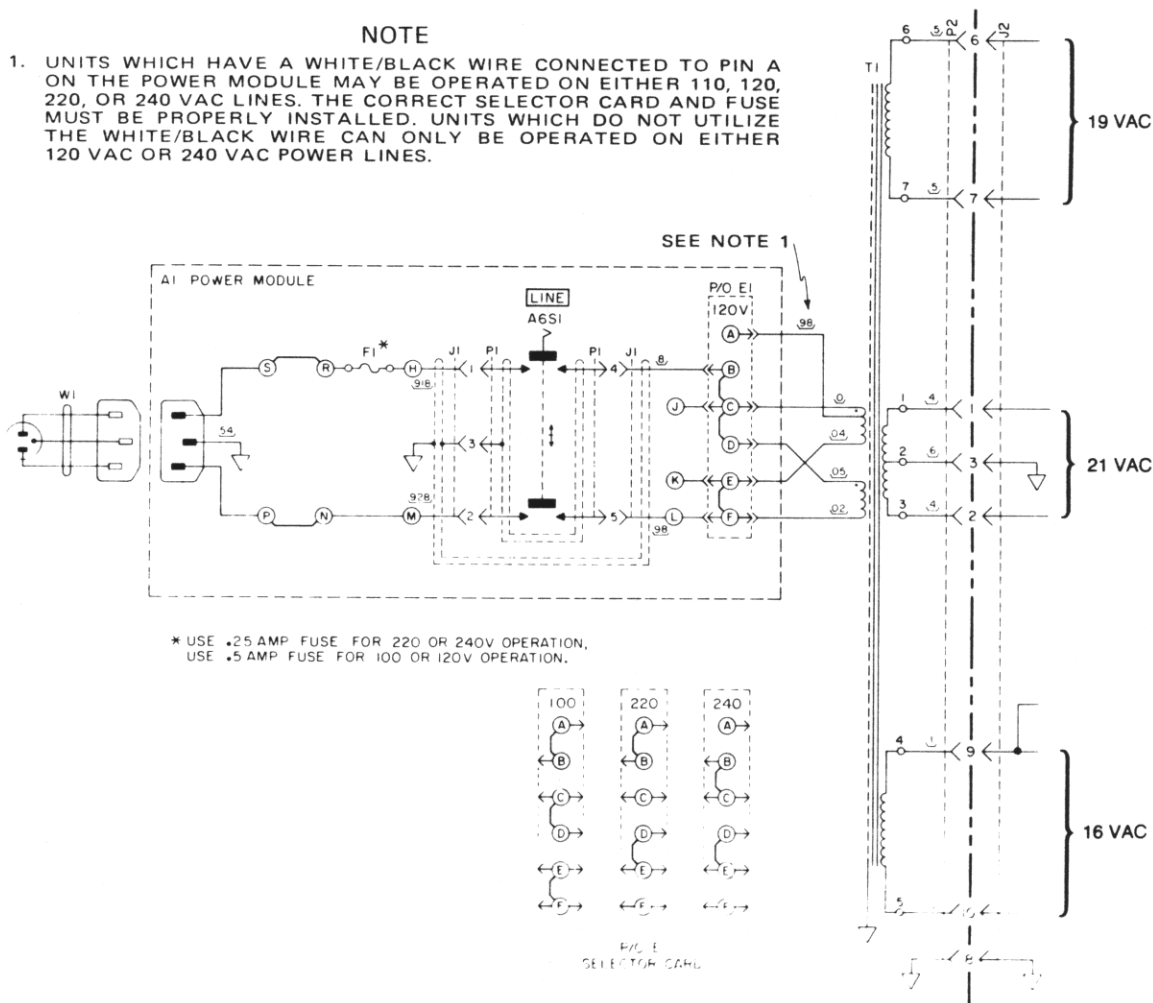
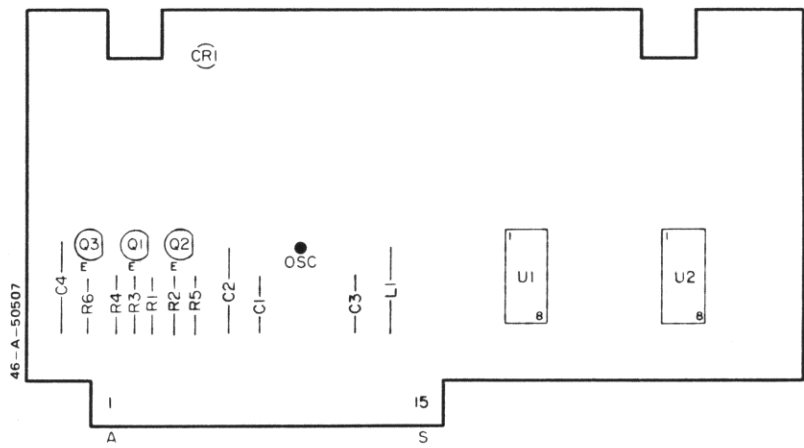
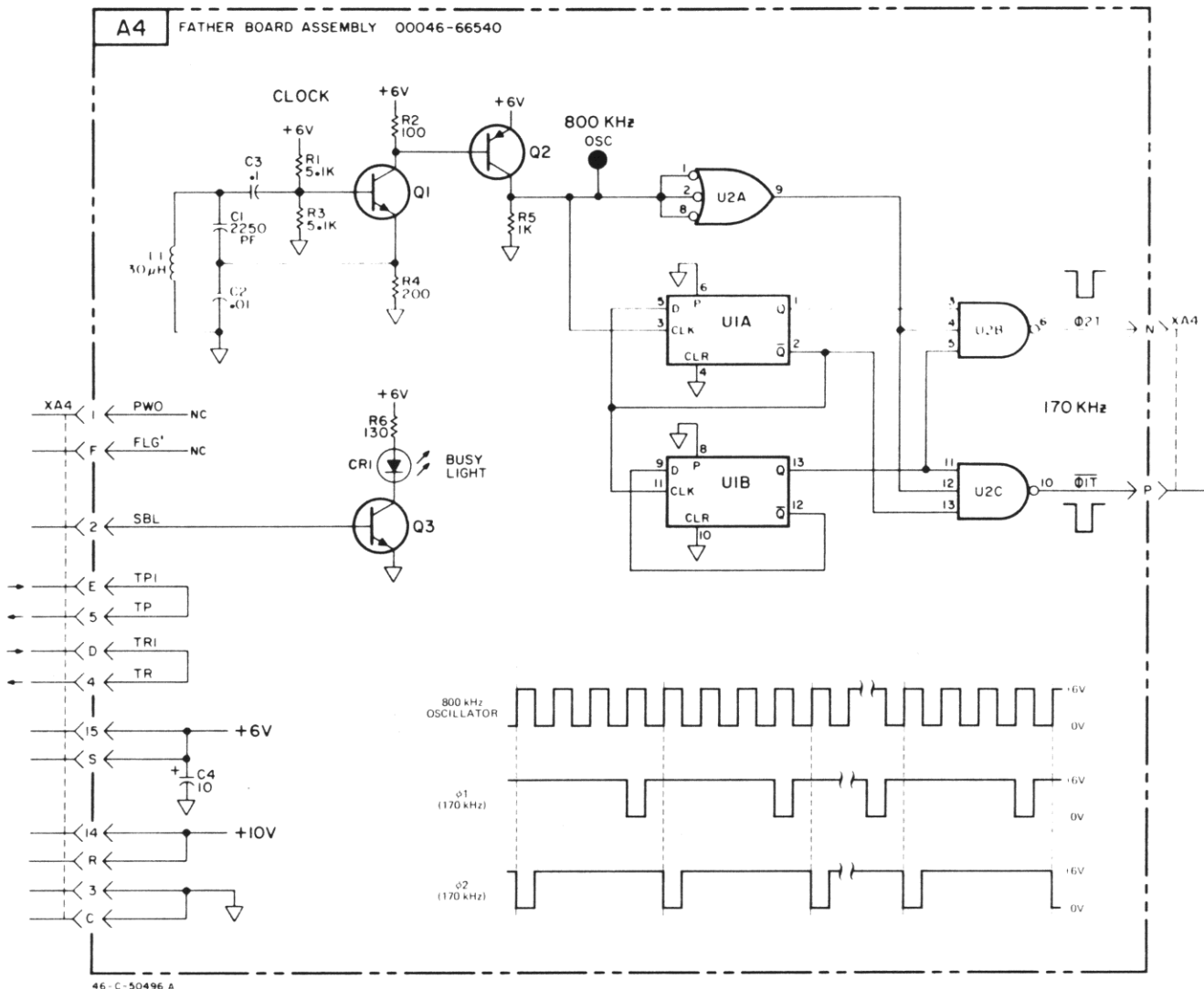

Figure 5-1. Primary Power Schematic





**Figure 5-2. A4 Father Board Schematic**



# Chapter 6

## REPLACEABLE PARTS

### INTRODUCTION

This chapter contains information for ordering replacement parts. Figure 6-1 shows the part numbers for keyboard keycaps. Table 6-1 contains -hp- ordering information only; manufacturers' part numbers are not provided.

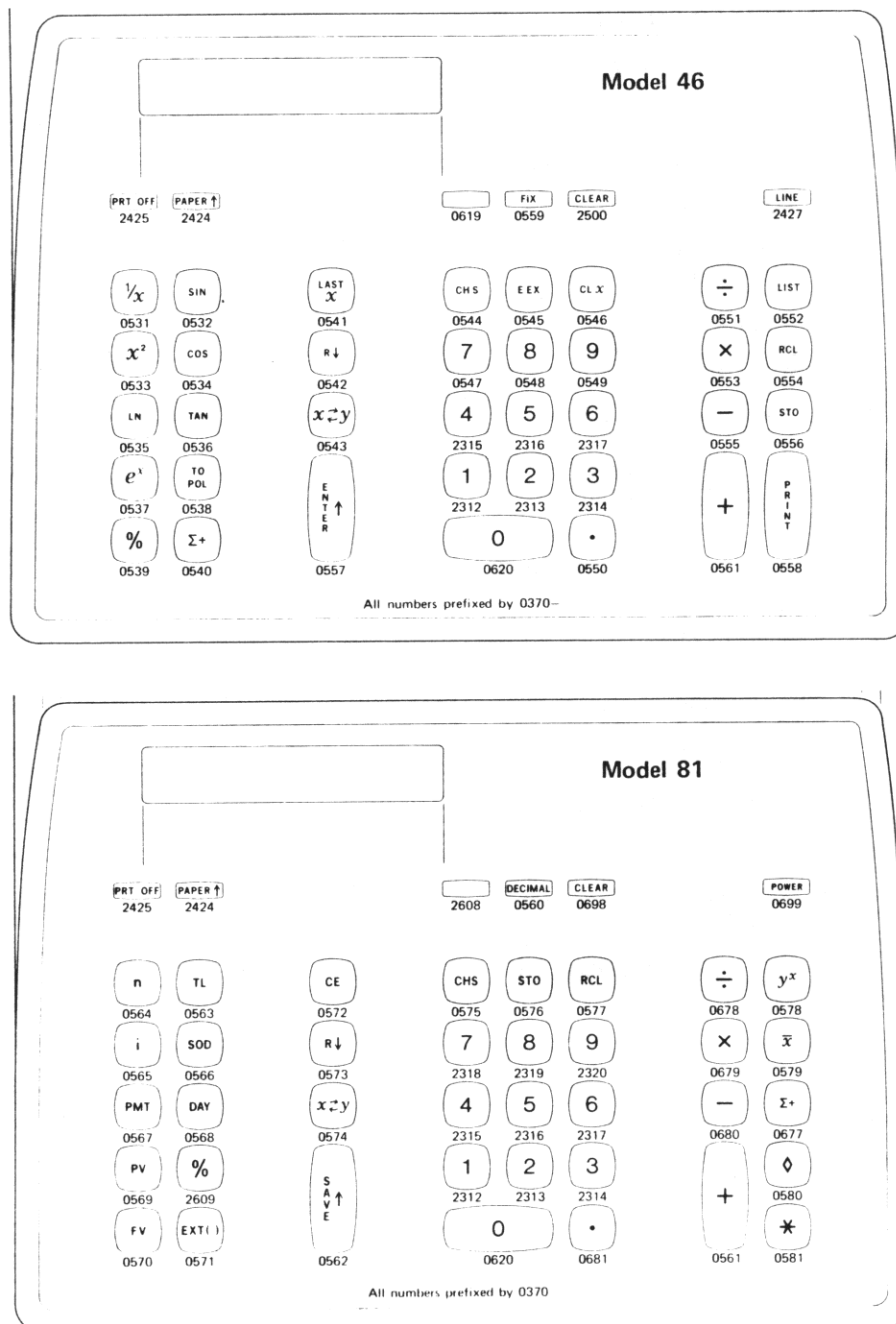

**Figure 6-1. Keycap Part Numbers**

Table 6-1. Replaceable Parts

REFERENCE DESIGNATOR	-hp- PART NO.	TQ	DESCRIPTION	MFR.	MFR. PART NO.
A1	5060-9422	1	LINE MODULE ASSEMBLY		
F1	2110-0202	3	FUSE, .5 amp SB (For 120V operation)		
F1	2110-0201	3	FUSE, .25 amp SB (For 240V operation)		
P1	1251-3170	1	CONNECTOR, SHELL, 6 PIN, MALE		
	1251-2989	5	CONNECTOR PINS, MALE		
J1	1251-3169	1	CONNECTOR, SHELL, 6 PIN, FEMALE		
	1251-2990	5	CONNECTOR PINS, FEMALE		
P2	1251-0525	1	CONNECTOR, 10 PIN, FEMALE		
T1	9100-3416	1	TRANSFORMER, POWER		
W1	8120-1378	1	AC POWER CORD		
	5061-0719	1	TRANSFORMER ASSEMBLY (Includes T1 and P2)		
	<b>00046-66540</b>	<b>1</b>	<b>PC BOARD - FATHER</b>		
C1	0140-0235	1	C: Fxd, 2250 PF; 300 V		
C2	0160-0207	1	C: Fxd, .01 $\mu$ F; 200V		
C3	0150-0121	1	C: Fxd, .1 $\mu$ F; 50V		
C4	0180-0374	1	C: Fxd, 10 $\mu$ F; 20V		
CR1	1990-0410	1	DIODE: LIGHT EMITTING (Busy)		
L1	9100-1624	1	COIL - CHOKE, 30 $\mu$ H		
Q1, Q3	1854-0071	2	TSTR: SI, NPN		
Q2	1853-0020	1	TSTR: SI, PNP		
R1, R3	0683-5125	2	R: Fxd, 5.1Kilohm $\pm$ , 5%		
R2	0684-1011	1	R: Fxd, 100ohm $\pm$ , 10%		
R4	0683-2015	1	R: Fxd, 200ohm $\pm$ , 5%		
R5	0684-1021	1	R: Fxd, 1Kilohm $\pm$ , 10%		
R6	0683-1315	1	R: Fxd, 130ohm $\pm$ , 5%		
U1	1820-0939	1	IC: CD 4013 AE (CMOS)		
U2	1820-0943	1	IC: CD 4023 AE (CMOS)		
			<b>MISCELLANEOUS</b>		
	00046-04101	1	COVER, BOTTOM		
	00046-00201	1	PANEL, REAR		
	4040-0983	1	BUCKET, PAPER		
	5040-7553	1	BOX, REFERENCE GUIDE		
	5061-0707	1	CASE, CARRYING		
	7120-3569	1	DECAL, PAPER LOAD		
	8520-0015	2	BRUSH, PARTS		
	9281-0415	2	PRINTER PAPER		
	9282-0511	1	PRINTER RIBBON		
	2200-0778	4	MACHINE SCREW (Printer Cover)		
			<b>LITERATURE</b>		
	00046-90005	1	OPERATING GUIDE (Model 46)		
	00081-90000	1	OPERATING GUIDE (Model 81)		
	00046-90031	1	SERVICE MANUAL (Model 46/81)		
	00081-90001	1	QUICK REFERENCE (Model 81)		

